

marmox *fiche technique*

SUR
MESURE

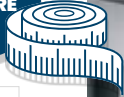

- 9010**
BLANC
- 7046**
GRIS CLAIR
- 7015**
GRIS ARDOISE
- 7037**
GRIS TAUPE
- 9005**
NOIR
- 3030**
TERRACOTA
- 5020**
BLEU JEAN
- 2010**
VERT AMANDE
- 7010**
VERT MOUSSE
- 1510**
ROSE PALE
- 3020**
BRUN
- 804**
BEIGE

RAL
À LA DEMANDE
DISPONIBLE



Solutions receveurs design

RÉSINE IMITATION PIERRE

graphite

Issu d'une pierre qui rappelle une tranche de graphite, ce modèle contemporain et texturé en diagonale est indémodable. Relativement texturé, il présente aussi une anti-dérapance naturelle.

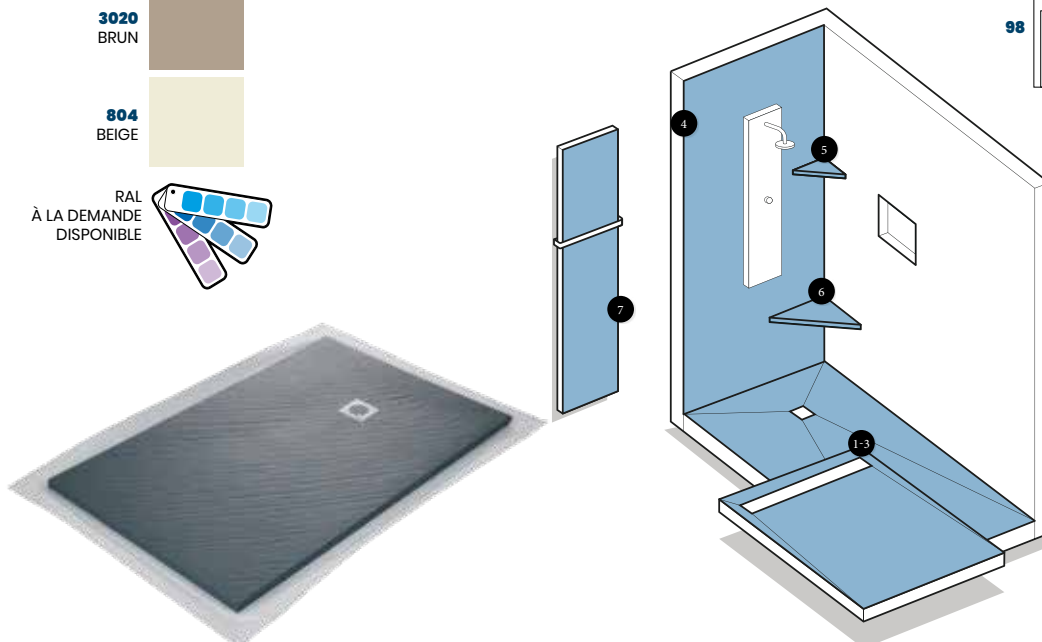

STANDARD

EN OPTION



REF. EPAISSEUR LONGUEUR LARGEUR
(mm)

squaregrid	2	115	115
tigergrid*	2	115	115
junglegrid*	2	115	115
hexagrid*	2	115	115
aquagrid*	2	115	115
pleine	1,5	700	70
tigerline*	1,5	700	70
jungleline*	1,5	700	70
hexaline*	1,5	700	70
aqualine*	1,5	700	70

*en option

SIPHON ORIENTABLE
VERTICAL OU HORIZONTAL

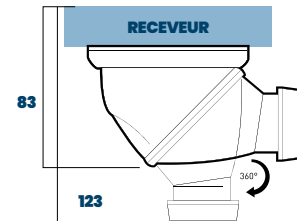

SIPHON ULTRA PLAT
HORIZONTAL

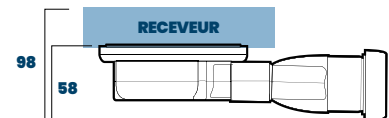

Produits disponibles
en finition **RESIN**

- 1-3** Receveurs ultra plats grille carrée et caniveaux
- 4** Panneaux d'habillages 200x100/250x100 ou 260x120/280x120 cm
- 5** Etagères d'angles
- 6** Bancs d'angles
- 7** Radiateurs et sèche serviette ultra-plat

Formats

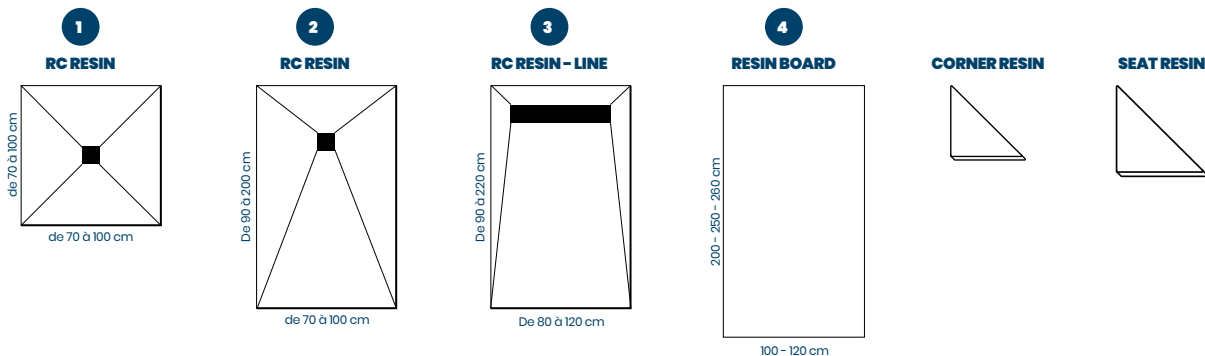

Caractéristiques techniques

Composition : résine solid surface imitation ardoise de 4 mm avec une âme en verre cellulaire. Finition gelcoat

Poids allégé : 20 kilos du m²

Pentes importantes supérieures à 2% pour une évacuation rapide de l'eau

Découpe : disque Diamant

Encollage : Mortier colle flex type C2S ou colle PU Kemflex

Natte étanche scellée avec la bride du siphon pour une garantie d'étanchéité périphérique.

Grille acier inox brossé : Acier inox 304 de 2 mm d'épaisseur.

Couleur des grilles : Revêtement anodisé epoxy

Résistant à tous les produits détergents

CE

Déclaration de performance disponible

RESIN Resine imitation pierre

RÉF	DÉSIGNATION	EPAISSEUR (CM)	LONGUEUR (CM)	LARGEUR (CM)	POS. SIPHON	POIDS NET (KG)	ÉCOULEMENT
1	RC 90 RESIN	2,5	90	90	45/45	16	Centré
1	RC 100 RESIN	2,5	100	100	50/50	22	Centré
2	RC 12080 RESIN	3	120	80	40/32	20	Décentré (Format Baignoire)
2	RC 12090 RESIN	3	120	90	45/32	24	Décentré (Format Baignoire)
2	RC 14090 RESIN	3	140	90	45/32	26	Décentré (Format Baignoire)
2	RC 16090 RESIN	3,5	160	90	45/32	32	Décentré (Format Baignoire)
2	RC 150100 RESIN	3	150	100	50/32	35	Décentré (Format Baignoire)
2	RC 18090 RESIN	3,5	180	90	45/32	40	Décentré (Format Baignoire)

RÉF	DÉSIGNATION	EPAISSEUR (CM)	LONGUEUR (CM)	LARGEUR (CM)	POS. SIPHON	POIDS NET (KG)	ÉCOULEMENT
3	RC 90 RESIN - LINE	3	90	90	45/35	16	Décentré (Format Baignoire)
3	RC 100 RESIN - LINE	3	100	100	50/35	22	Décentré (Format Baignoire)
3	RC 12080 RESIN - LINE	3,5	120	80	40/35	21	Décentré (Format Baignoire)
3	RC 12090 RESIN - LINE	3,5	120	90	45/35	24	Décentré (Format Baignoire)
3	RC 14090 RESIN - LINE	4	140	90	45/35	26	Décentré (Format Baignoire)
3	RC 150100 RESIN - LINE	4	150	100	50/35	35	Décentré (Format Baignoire)
3	RC 18090 RESIN - LINE	4	180	90	45/35	40	Décentré (Format Baignoire)

RÉF	DÉSIGNATION	EPAISSEUR (CM)	LONGUEUR (CM)	LARGEUR (CM)	POIDS NET (KG)
4	RESIN BOARD-200/100	1	200	100	20
4	RESIN BOARD-250/100	1	250	100	28
4	RESIN BOARD-260/120	0,3 - 0,4	260	120	6



Nous vous recommandons de lire intégralement la notice avant de commencer votre installation. Utilisation de pieds ou plots de receveur interdite.

We recommend that you read all the instructions carefully before starting to install your shower. Never use shower tray feet or mounting blocks.

Wij raden u aan de montagehandleiding aandachtig te lezen vóór u met de plaatsing begint. Het gebruik van voetjes of blokjes bij de douchebak is verboden.

Le aconsejamos que lea las instrucciones completamente antes de empezar la instalación. Prohibido el uso de pies o tacos de plato de ducha.

Wir empfehlen Ihnen, die Montageanweisung vor Beginn der Montage vollständig zu lesen. Die Verwendung von Duschwannenfüßen ist unzulässig.

Recomendamos que leia totalmente o folheto informativo antes de iniciar a instalação. Não é permitida a utilização de apoios ou cavilhas para base de duche.

Leggere le istruzioni nella loro integralità prima di procedere all'installazione. È vietato utilizzare piedi o blocchetti per piatto doccia.

Рекомендуем внимательно прочесть инструкцию по сборке перед началом работ. Запрещено устанавливать душевой поддон на ножки или подставки.





not included

1



Mortier/Mortar/Mortel/Mortero/Mörtel/Cimento/Malta/Строительный раствор

2



Colle PVC/PVC adhesive/PVC-lijm/Cola de PVC/PVC-Kleber/
Cola de ladrilho/Cola per piastrelle/ Плиточный клей

3



Colle carrelage/Tiling glue/Tegellijm/Cola para azulejos/Fliesenkleber/
Cola de ladrilho/Cola per piastrelle/ Плиточный клей

4



Bande de résilience/ Adhesive sealing band/ Slagsterksterook/ Cinta resiliente/
selbstklebendes Abdichtband für Duschbecken/ Fita de vedação/ Nastro di
resilienza/ Самоклеящаяся гидроизоляционная лента

5



Enduit d'imperméabilisation/Sealant/Waterdichtende afdekking/ Recubrimiento de
impermeabilización/Dichtungsmasse/ Camada de impermeabilização/Rivestimento
di impermeabilizzazione/ Изоляционное покрытие



not included

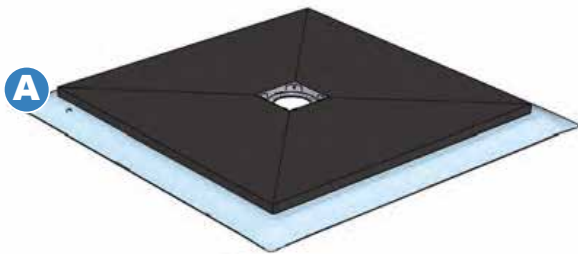

JAMES



not included

SLIM

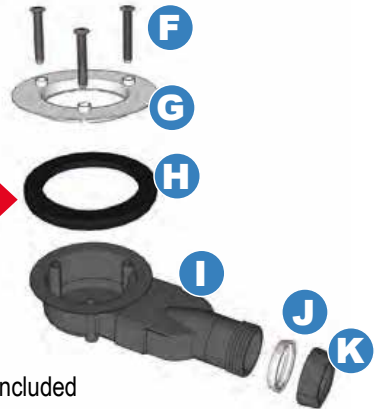

not included

← Or →



not included

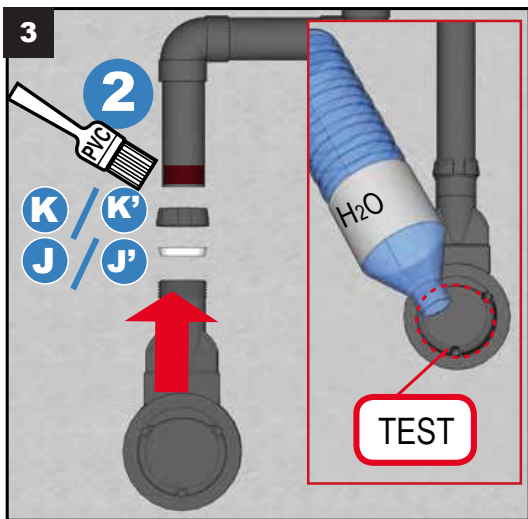
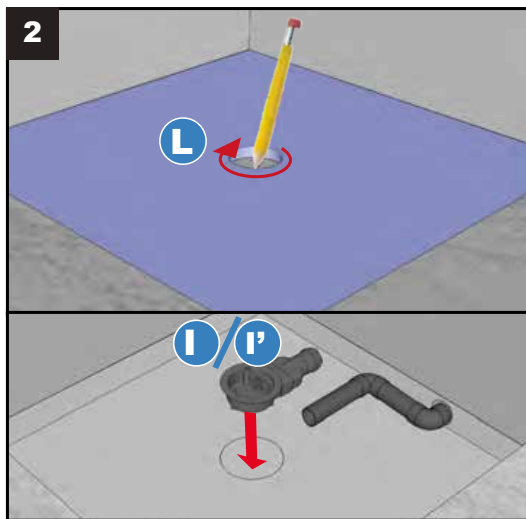
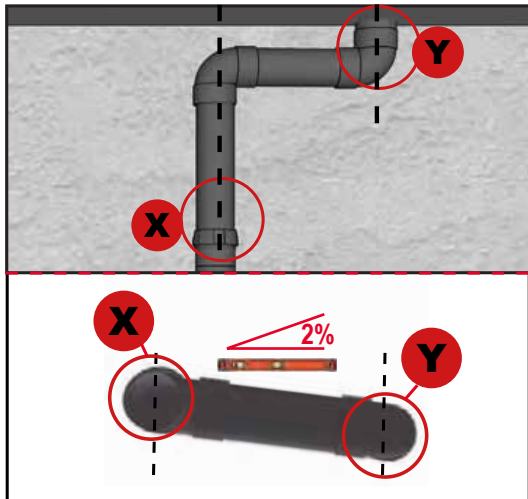
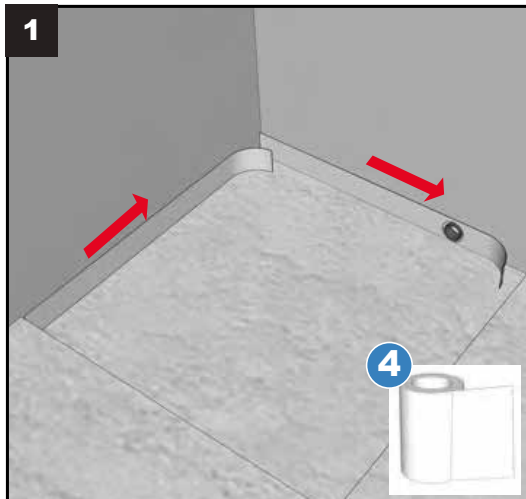

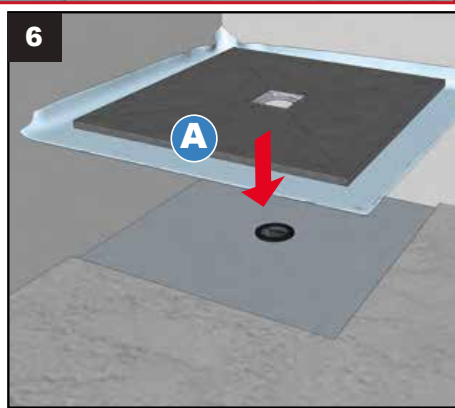
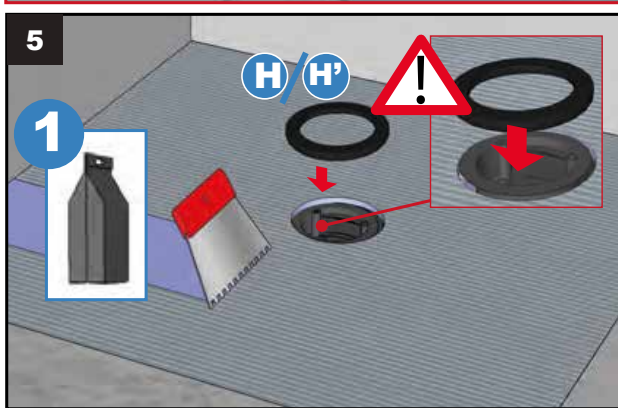
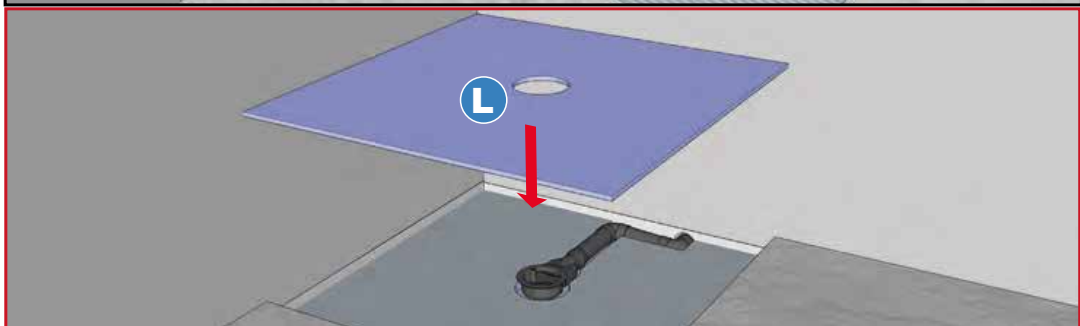
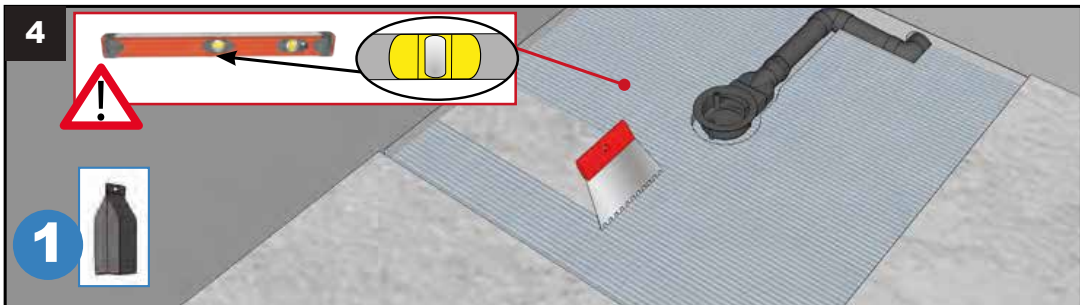

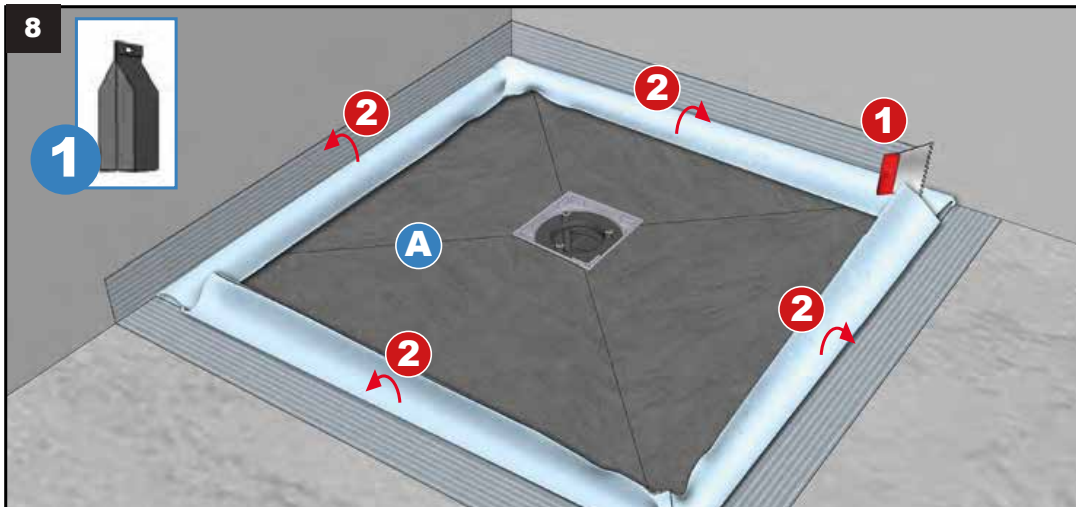
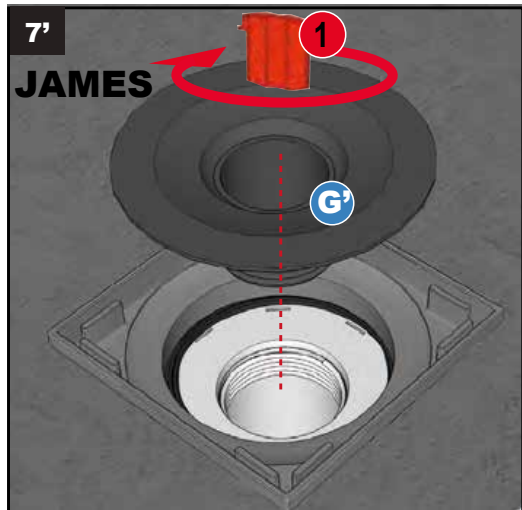
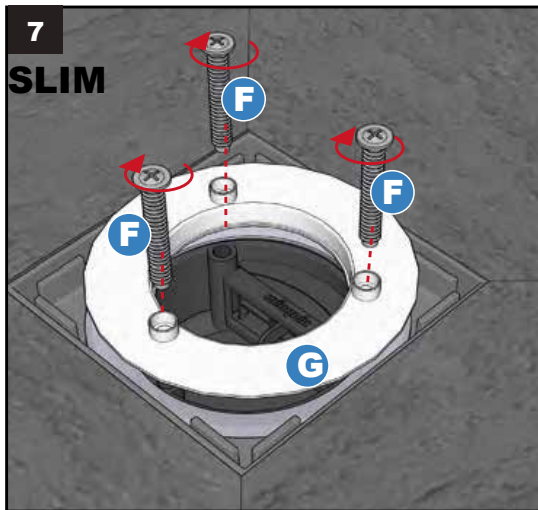

9

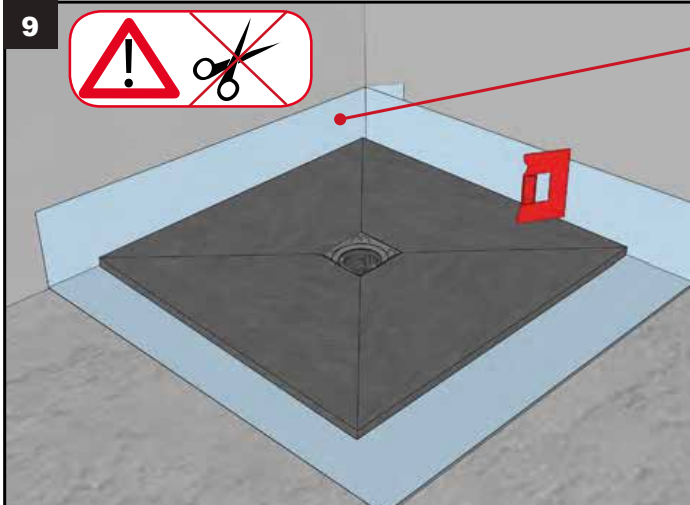

1

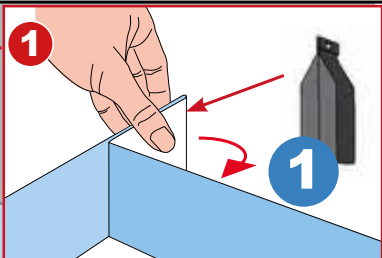

2

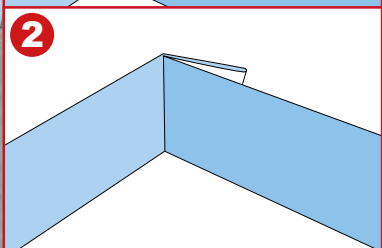

10

3

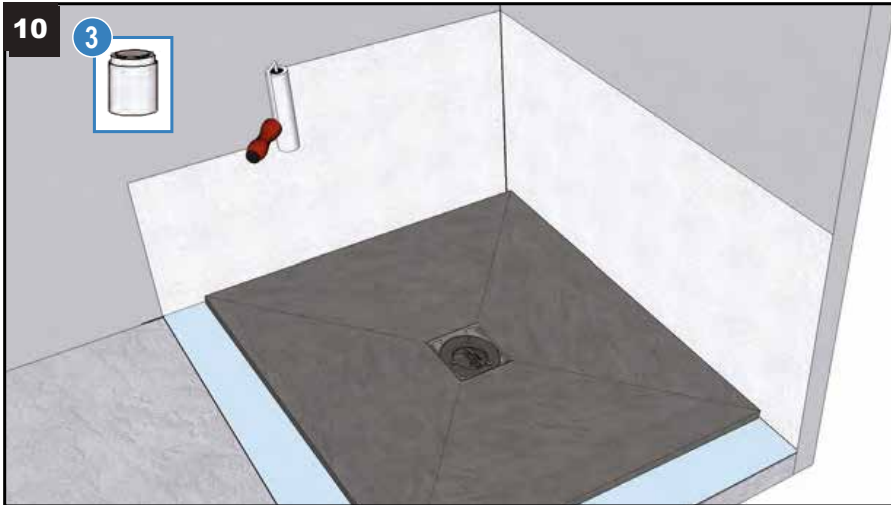

Carrelage/Tiling/Tegels/Azulejos/
Fliesen/Ladrilho/ Piastrellatura/
Облицовка плиткой

3

Colle carrelage/Tiling glue/Tegellijm/
Cola para azulejos/Fliesenkleber/
Cola de ladrilho/Colla per piastrelle/
Плиточный клей

5

Enduit d'imperméabilisation/
Sealant/Waterdichtende
afdekking/ Recubrimiento
de impermeabilización/
Dichtungsmasse/
Camada de impermeabilização/
Rivestimento di
impermeabilizzazione/
Изоляционное покрытие

1

Mortier/Mortar/Mortel/Mortero/Mörtel/
Cimento/Malta/Строительный
раствор

4

Bande de résilience/ Adhesive
sealing band/ Slagsterktestrook/ Cinta
resiliente/ selbstklebendes Abdichtband
für Duschbecken/ Fita de vedação/
Nastro di resilienza/ Самоклеящаяся
гидроизоляционная лента

A

I

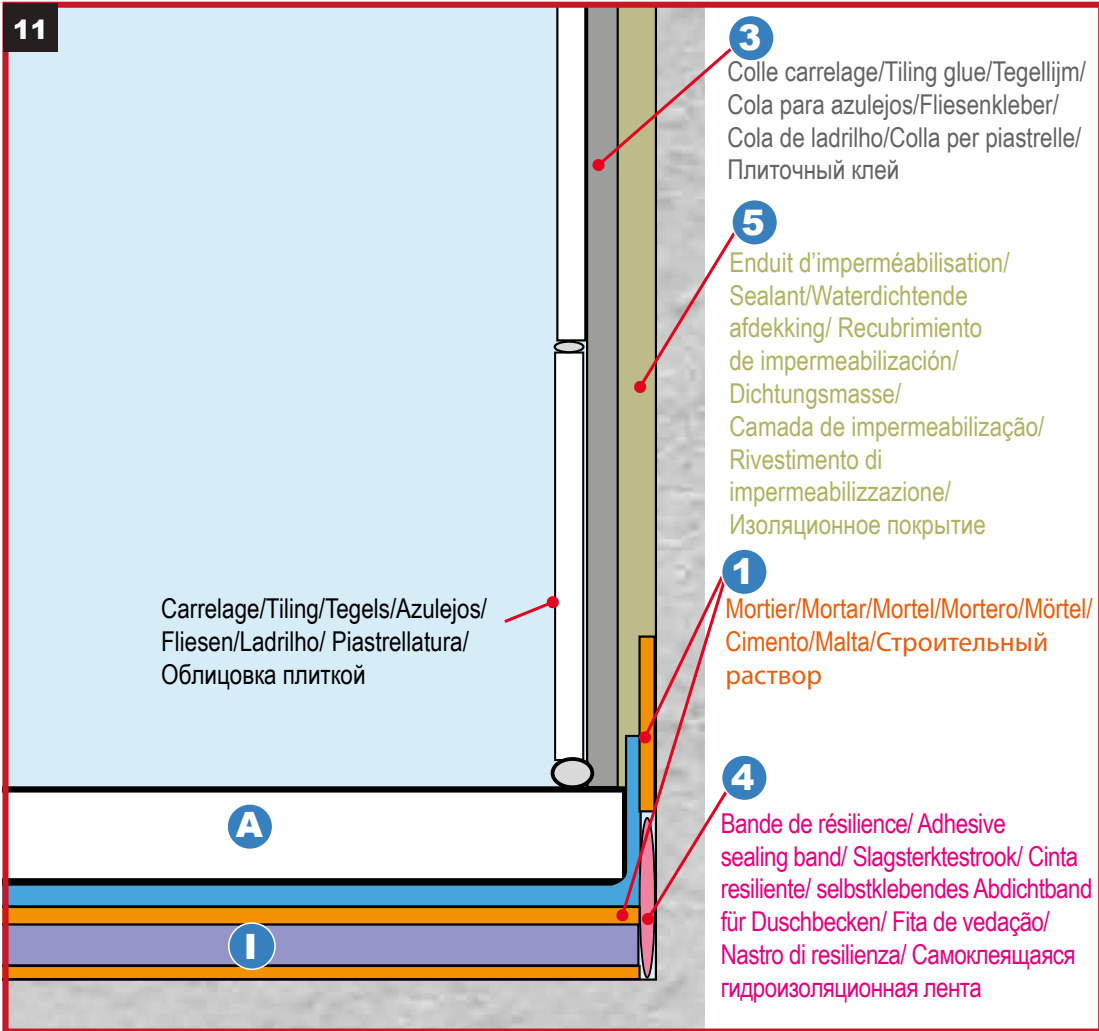

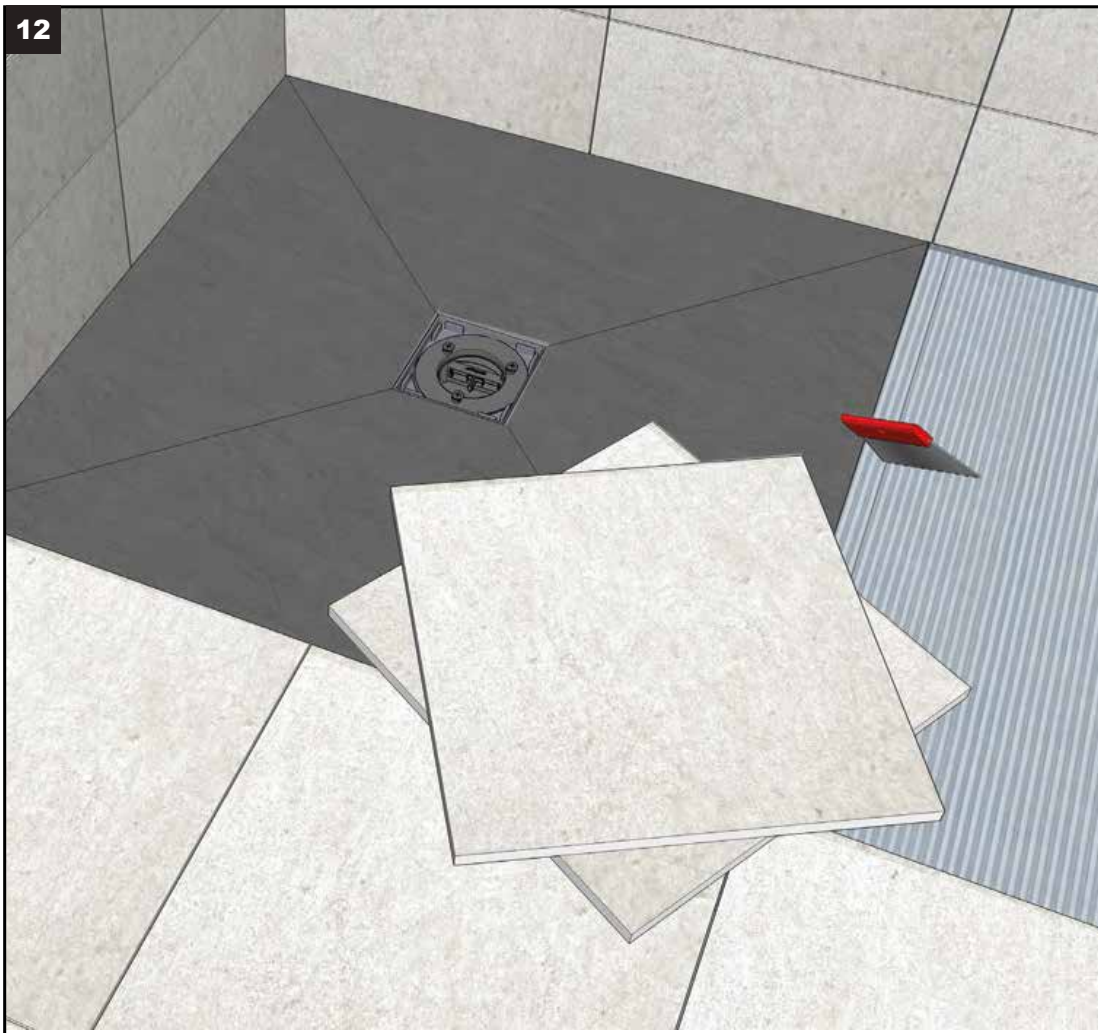

13 SLIM

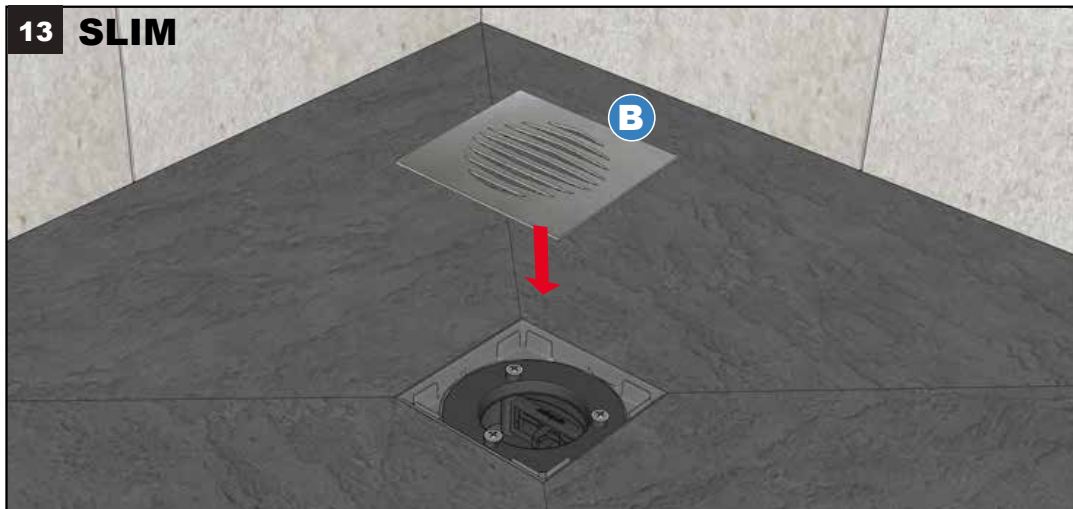

13' JAMES

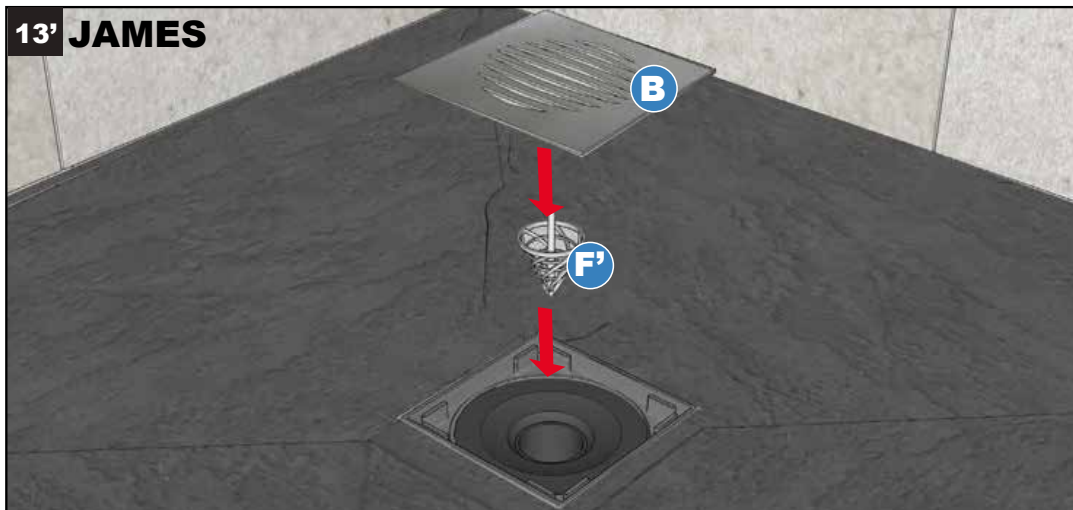



PAROI DESIGN

marmox

Vidéo de montage :



Not. ParoiDesign 05/2022



Les Outils à prévoir

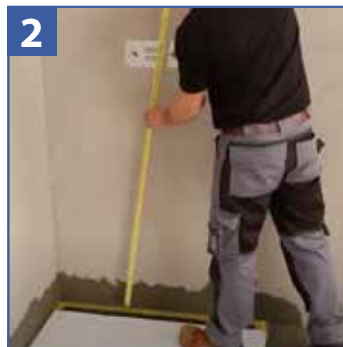

Relever les côtes des arrivées d'eau.



Reporter les cotes sur le panneau (Astuce: utiliser un adhésif de masquage léger pour reporter vos côtes).



Effectuer les découpes à l'aide de disques diamant pour une découpe nette et rapide.

**5**

Positionner les câbles d'espacement de 3 à 4 mm pour espacer le panneau du receveur.

**6**

Encoller le panneau à l'aide de la colle PU marmox ACC010, d'un mastic colle MS Polymère ou d'une colle carrelage pour faïence grand format.

**7**

Installer le panneau en vous assurant du bon alignement des arrivées d'eau.

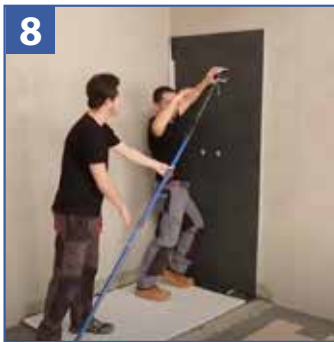
**8**

Caler le panneau pendant le séchage à l'aide d'un étau jusqu'au séchage intégral de la colle.

**9**

Sceller la natte étanche périphérique du panneau mural.

**10**

Installer le troisième panneau d'habillage avec le même processus que les deux premiers panneaux.

**11**

Appliquer trois croisillons autonivelants répartis sur la hauteur entre les deux panneaux.

**12**

Réaliser un joint mortier ou epoxy de 3 mm entre les panneaux pour assurer une dilatation et une étanchéité entre les panneaux.

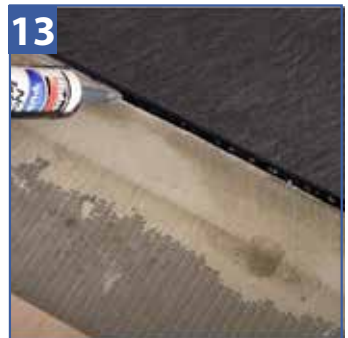
**13**

Réaliser un joint périphérique à l'aide du mastic colle PU Marmox ACC010 pour assurer une bonne dilatation de l'ouvrage.